

WEQ-8(2).2C

Height: 18.95" Width: 6.12" Depth: 5.54"
(48.1cm) (15.5cm) (14.1cm)



- Designed for low to medium volume applications using a unique blend of catalytic coconut shell carbon, each filter rated up to 18,000 gallons chloramine and chlorine taste and odor reduction for consistent, great tasting cold and hot beverages, hot water, and ice
- Protects downstream equipment with exceptional sediment holding capacity and reduces health contaminants such as cyst with 0.2 Microns mechanical filtration
- Save on maintenance and service costs with a scale control blend that's up to 8 times more scale control capacity, specifically engineered to match the entire chlorine capacity life resulting in reduced scale build-up on evaporator plates and heating coils in both ice machines and coffee brewers
- Certified to NSF Standard 53 for Cyst and Standard 42 for Sediment, Chlorine Taste and Odor reduction
- Sanitary quick connect valve-in-head design simultaneously shuts off and vents water with ¼ turn, allowing for simple cartridge change-outs and maintenance times
- Unique modular filter head manifold design allows for simple installation, customization, and future system expansion
- Auto-leveling technology ensures perfect installation every time
- Includes single stage filter head assembly with manifold bracket, 3/8" MNPT fittings and 1/4" quick-connect rinse valve

NOTE: Do not use with water that is microbiologically unsafe or of unknown quality without adequate disinfection before or after the system.

Specifications

Product #: 56000.0036

Cartridge Type: Quick Change

Application(s): Tea, Post Mix, Ice, Drinking Water, Coffee, Backroom Package/ Combo System

Replacement Cartridge: 56000.0128

Filtration Type: Sediment, Cyst Reduction, Chlorine Taste & Odor, Chloramines

Filter Change Frequency: Annual

Capacity

Micron Rating	Service Flow Rate	Water Filter Capacity Chlorine Reduction	Water Filter Capacity Chloramine Reduction	Water Filter Capacity Softening
0.2	2.0 gal/min (7.6 L/min)	-	18000 gal. (68136.2 L)	-

Plumbing Requirements

Inlet Connection	Outlet Connection	Min Operating Pressure	Max Operating Pressure	Min Operating Temperature	Max Operating Temperature
3/8 IN	3/8 IN	20 psi (138 kPa)	125 psi (862 kPa)	40°F(4°C)	100°F(38°C)

WARNING:



BUNN® reserves the right to change specifications and product design without notice. Such revisions do not entitle the buyer to corresponding changes, improvements, additions or replacements for previously purchased equipment. For most current specifications and other info visit bunn.com.

Last Updated:
11/19/2024

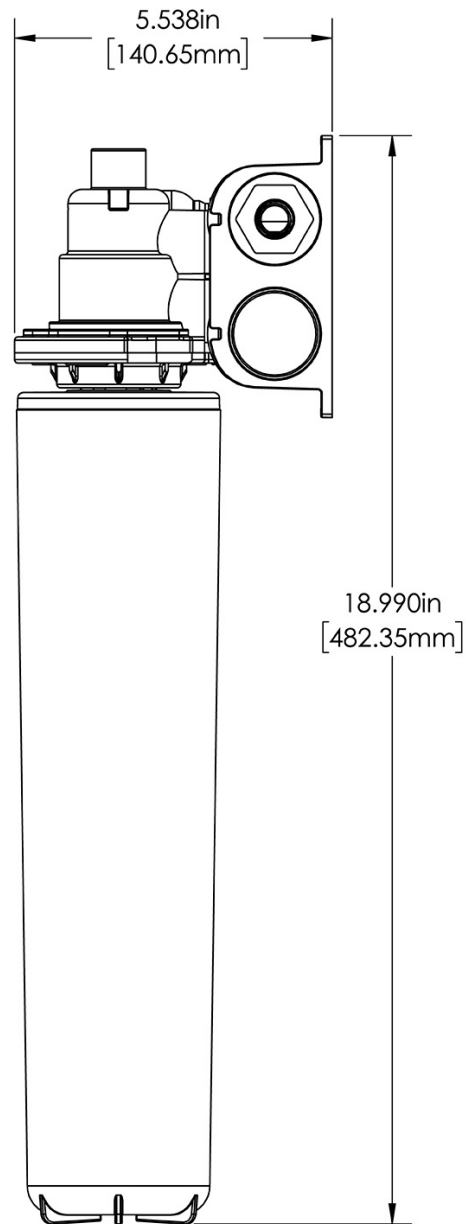
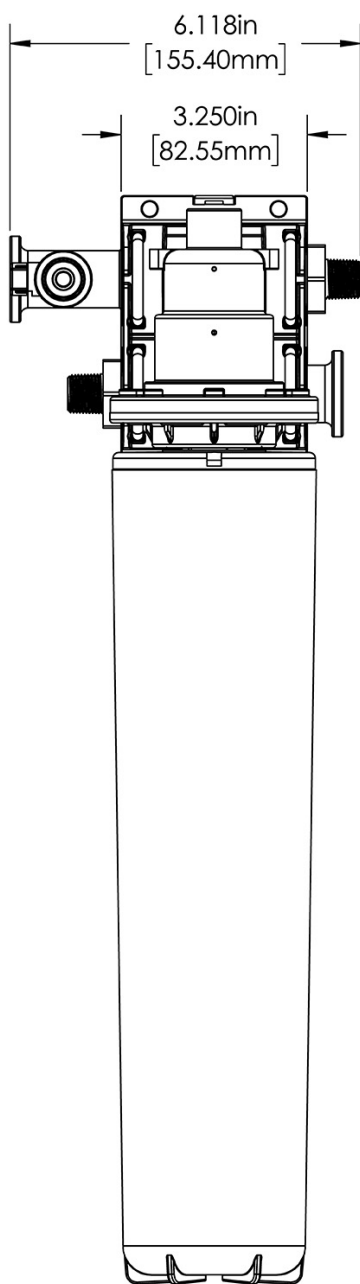

Dimensions of Filter System <i>(filter head with filter cartridge)</i>			Installed Dimensions <i>(Installation with wall mounting)</i>			Cartridge Dimensions <i>(filter cartridge only)</i>			
	Height	Width	Depth	Height	Width	Depth	Height	Width	Depth
English	18.95 in.	6.12 in.	5.54 in.	-	-	-	16.46 in.	3.56 in.	3.56 in.
Metric	48.1 cm	15.5 cm	14.1 cm	-	-	-	41.8 cm	9.0 cm	9.0 cm

Weight			Shipping				
	Dry	Wet	Height	Width	Depth	Weight	Volume
English	0.0 lbs	0.0 lbs	8.00 in.	15.00 in.	20.00 in.	7.920 lbs	-
Metric	-	-	20.3 cm	38.1 cm	50.8 cm	3.593 kgs	-

WARRANTY: BUNN High Performance Water Filtration Solutions Systems by BUNN® (excluding water filters and water treatment replacement cartridges) are covered by a limited warranty against defects in material and workmanship for a period of five years after date of purchase, under normal use and service, and when installed in accordance with manufacturer's recommendations outlined in the filtration systems owner's manual. BUNN replaceable elements (water treatment cartridges, filter elements, and feeder elements) are covered by a limited warranty against defects in material and workmanship for a period of one year after date of purchase or the remainder of the original warranty, whichever is longer. See printed warranty for full details. BUNN will provide a copy of the warranty upon request.



BUNN® reserves the right to change specifications and product design without notice. Such revisions do not entitle the buyer to corresponding changes, improvements, additions or replacements for previously purchased equipment. For most current specifications and other info visit bunn.com.

Last Updated:
11/19/2024

Related Products & Accessories: WEQ-8(2).2C(56000.0036)



CARTRIDGE, WEQ-18
(2).2C

Product #: 56000.0128



HEAD ASSEMBLY, WEQ-
SINGLE

Product #: 56000.0201



BUNN® reserves the right to change specifications and product design without notice. Such revisions do not entitle the buyer to corresponding changes, improvements, additions or replacements for previously purchased equipment. For most current specifications and other info visit bunn.com.

Last Updated:
11/19/2024

Model Compatibility: WEQ-8(2).2C(56000.0036)

Serving and Holding selections are currently unavailable. Please contact your sales representative to find out more information.



BUNN® reserves the right to change specifications and product design without notice. Such revisions do not entitle the buyer to corresponding changes, improvements, additions or replacements for previously purchased equipment. For most current specifications and other info visit bunn.com.

Last Updated:
11/19/2024